

## QUICK REFERENCE GUIDE



**Manufacturer:**

AFL

**Product Name:**

AFL FlowScout® OLS8-Quad Optical Light Source (850, 1300, 1310, 1550nm)

**Manufacturer Part Number:**

OLS8-SL4-BAS

▶ [Click here for more details on the AFL FlowScout® OLS8-Quad Optical Light Source \(850, 1300, 1310, 1550nm\)](#)



**Test & Inspection**

# FlowScout® OLS8 Series Light Sources and OPM8 Series Optical Power Meters

## Quick Reference Guide

**Contact the professionals at Fiber Optic Center for a quote or to get more details.**

[focenter.com](http://focenter.com) • 508-992-6464 | (800) 473-4237 • [sales@focenter.com](mailto:sales@focenter.com)

23 Centre Street • New Bedford, MA 02740 USA

*Product data subject to change  
without notice.*

## OPM8/OLS8 Battery & Power Status

State	Power Indicator	Fully Charged	¾ Charged	½ Charged	¼ Charged	<10% Charged
Not Charging / On	Power Icon (software)					
	Hard Power button (Off)					
Charging / On	Power Icon (software)					
	Hard Power Button					
Charging / Off	Power Icon (software)	N/A				
	Hard Power Button					

### Configuring OPM8/OLS8 to Auto-Off

1. From the OPM8/OLS8 Home screen, touch Settings - .
2. Locate and select the Auto-Off Timer menu.
3. From the Auto-Off Timer menu, select the desired power save option (2, 5, 10 minutes, Never).

#### Settings Screen

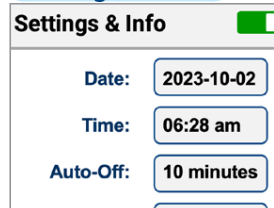

#### Auto-Off Menu

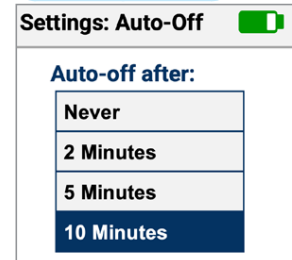

Contact the professionals at Fiber Optic Center for a quote or to get more details.

## OPM8 Controls and Interfaces



### Hard Buttons

1. Power button - press and hold to turn on; press to turn off.  
**Note:** power button also serves as Charge Indicator, see ["OPM8/ OLS8 Battery & Power Status"](#) on page 2.
2. Home button- from any screen, press to return to the Home screen.
3. Wavelength button - while in the Measurement screen, press to cycle through the available wavelengths. To enable additional wavelength see ["OPM8 General Settings"](#) on page 6.  
**Note:** When an OPM8 is receiving a wavelength ID'd light, it automatically switches to the ID wavelengths.

### Interfaces

4. Optical input - must be equipped with the appropriate adapter.
5. Display - large intuitive color touchscreen.
6. USB port for charging, transferring results, and firmware upgrade.

### Home Screen Soft Buttons and Indicators

7. Measurements button- touch to go to the Measurements screen.
8. Settings button - touch to display Settings and Info screen, see ["OPM8 General Settings"](#) on page 6.
9. Results button - touch to display Saved results screen.
10. Battery state indicator - see ["OPM8/OLS8 Battery & Power Status"](#) on page 2.

Contact the professionals at Fiber Optic Center for a quote or to get more details.

## OPM8 Measurement Screen Soft Buttons and Indicators

### Soft Buttons Functionality

1. **Ref = Set Reference button:** allows the user to view current Reference(s) or set the new Reference(s).
  - Short press displays the current Reference Power in dBm for each detected or selected wavelength. After 3 seconds, display reverts to previously displayed power or loss
  - Long press stores the current power measurement(s) as new Reference(s) and displays Loss in dB relative to new Reference(s). Displayed Loss should be ~0.0 dB at each received wavelength after storing Reference.
2. **dB/dBm = Toggle Power/Loss button:** press to toggle the displayed measurements between insertion loss in dB and power in dBm.
3. **Save Results button:** press to save the displayed power/loss measurements in the OPM8 internal memory. Saved test results are organized into 'Project' user-defined folders.
4. **Back button:** press to return to the Home screen.

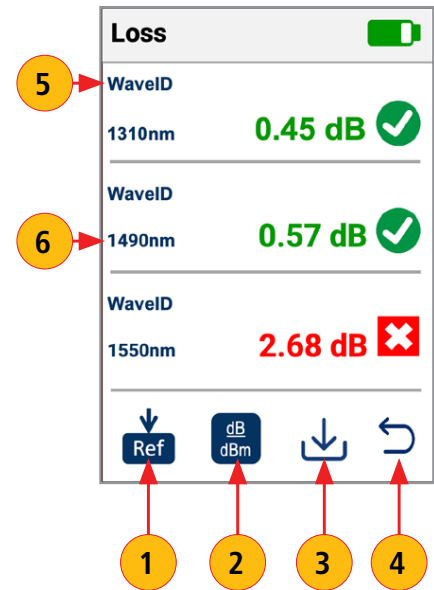

## OPM8 Measurement Screen Soft Buttons and Indicators

### Indicators

5. **Detected Signal Type** - this field displays one of the following:
  - Wave ID - displayed if the OPM8 is receiving a wavelength ID'd light.
  - 270 Hz (330 Hz, 1 kHz, 2 kHz) - displayed if the OPM8 is receiving a Tone signal.
  - Blank field indicates that OPM8 is receiving CW light.
6. **Wavelength** - this field displays one of the following values:
  - Wave ID detected wavelength(s).
  - User-selected wavelength (if paired with light source operating in CW or Tone).
7. **Screen Title** - indicates currently displayed measurements: Power or Loss
8. **Measurements values** - displays measured Power in dBm or Loss in dB
9. **Pass/Fail indicator** - will display one of the following:
  - Passing result is indicated by **✓ in Green circle**
  - Failing result is indicated by **X in Red box**
  - Blank field indicates that pass/fail is not evaluated; Pass/Fail is not enabled in Settings.

The screenshot shows a measurement screen titled "Loss" with a battery icon in the top right. The screen displays a table of measurements with three rows. Callout 5 points to the "WaveID" column, callout 6 points to the "Wavelength" column, callout 7 points to the "Screen Title" (Loss), callout 8 points to the "Measurements values" column, and callout 9 points to the "Pass/Fail indicator" column. The table shows the following data:

WaveID	Wavelength	Measurements values	Pass/Fail indicator
1310nm		0.45 dB	✓
1490nm		0.57 dB	✓
1550nm		2.68 dB	X

At the bottom of the screen, there are four soft buttons: "Ref" (with a downward arrow), "dB dBm" (with a dB symbol), a download icon, and a refresh icon.

## OPM8 General Settings

### Settings - Screen 1

**Settings & Info**

Date: 2023-10-02

Time: 06:28 am

Auto-Off: 10 minutes

Brightness: High

Auto-Dim: 10 Sec

Bluetooth:

Touch a Setting to edit

Enable/Disable Bluetooth

Touch to display more Settings and Info

### Settings - Screen 2

**Settings & Info**

P/F Limits:

Add Wavelengths:

**Device Information**

Model: FlowScout OPM8-H

Serial #: 2M43BB01293

Calibrated: 2023-08-15

Software: 1.3.28

Touch to display Power/Loss Pass/Fail limits screen

Enable/disable: when enabled, more wavelengths can be added to toggle using the λ hard button

Touch to display Home screen

### Configuring Pass/Fail Limits

**Loss Pass/Fail**

Loss Pass/Fail

λ (nm)	Max (dB)
850	2.10
1300	2.10
1310	2.00
1490	2.00
1550	2.60

Cancel  dB dBm Done

Enable/disable Power/Loss Pass/Fail limits

Touch a Min field to edit Min value

Toggle between Power & Loss Pass/Fail

**Power Pass/Fail**

Power Pass/Fail

λ (nm)	Min (dBm)	Max (dBm)
850	-28.00	+5.00
1300	-28.00	+5.00
1310	-32.00	+10.00
1490	-28.00	+5.00
1550	-28.00	+5.00

Cancel  dB dBm Done

Touch a Min/Max field to edit Min/Max value

Scroll up/down to see previous/next page

Save edits and return to previous screen

Discard edits and return to previous screen

Contact the professionals at Fiber Optic Center for a quote or to get more details.

## OPM8 - Saving Results

### To Save Results

1. From the Measurements screen, touch Save.
2. Define Project name, OPM End, OLS End, Cable, and Fiber # fields used to name saved results.
  - Touch the desired field to display the String/Number editor sub-screen.
  - Make edits using on-screen controls. Touch Done to save new name and return to the Save screen.
3. Touch Done to save results in the newly created Project.

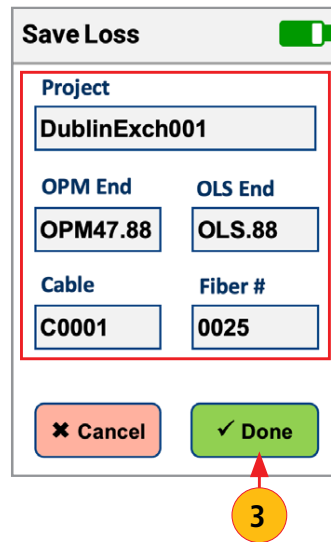
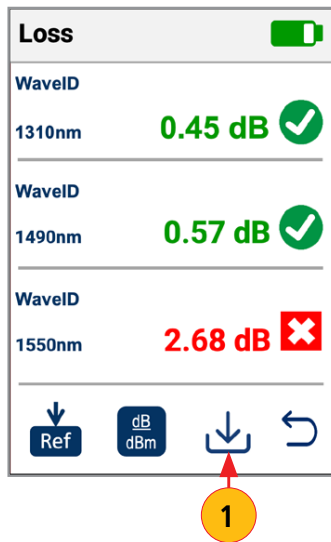

- Project name, OPM End, OLS End, Cable, and Fiber # are user-defined in String Editor.
- Fiber # auto-increments after each save, but can be modified in Number Editor as needed.
- The user may edit fields as needed to configure new Project or save result using currently configured fields.

**Contact the professionals at Fiber Optic Center for a quote or to get more details.**

## OPM8 - Viewing or Deleting Saved Results

### To View Saved Results

1. From the OPM8 Home screen, touch Results to display the Results Manager.
2. In the Saved Projects screen, touch the desired Project to display test results.
3. Touch the desired result to display Power/Loss measurements.
4. Scroll up/down to view additional Projects / Results / Measurements.
5. Touch dB/dBm button to toggle measurements between Power & Loss.

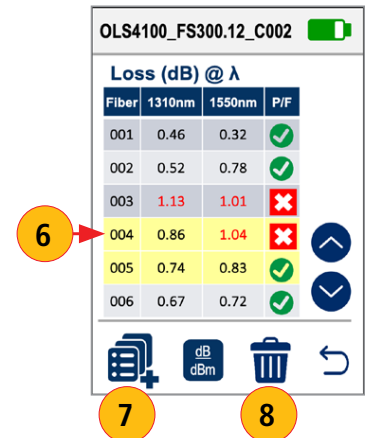
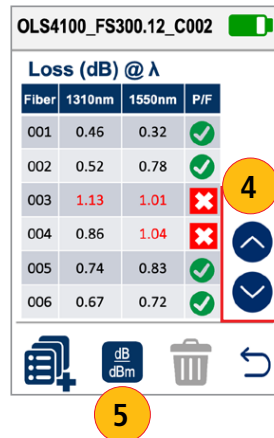
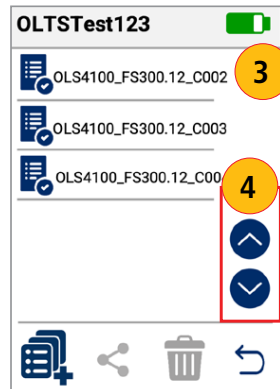
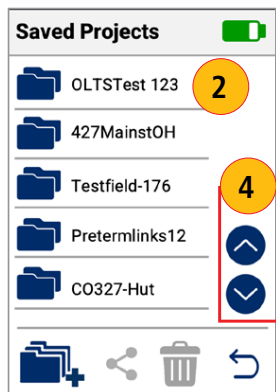

### To Delete Saved Results

6. Touch and hold the desired saved result (Project or Measurement) to select it for deletion.
7. To select multiple results touch the Multi-select button, then touch the desired results.
8. Touch Delete.



## OLS8 Controls and Interfaces



### Hard Buttons

1. Power button - press and hold to turn on; press to turn off.  
**Note:** power button also serves as Charge Indicator, see ["OPM8/ OLS8 Battery & Power Status"](#) on page 2.
2. Home button- from any screen, press to return to the Home screen.
3. Light button - press to enable/disable light source.  
**Note:** when the light is enabled, the Home & Light buttons and Light indicator (11) are illuminated to indicate that light is enabled.

### Interfaces

4. Output port - must be equipped with the appropriate adapter.
5. Display - large intuitive color touchscreen.
6. USB port for charging, transferring results, and firmware upgrade.

### Home Screen Soft Buttons and Indicators

7. Settings button - touch to display Settings and Info screen.
8. Wavelength button - touch to change/select wavelength.
9. Source mode button - touch to change/select mode.
10. Light indicator - illuminates when light source is enabled:  
Solid red = CW; Blinking Red = Wave ID and Tone
11. Battery state indicator - see ["OPM8/OLS8 Battery & Power Status"](#) on page 2.

## OLS8 - Selecting mode and Wavelength

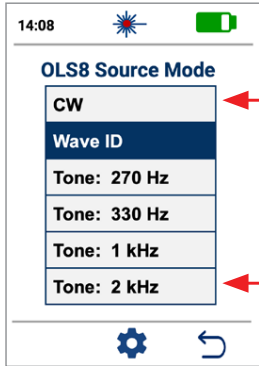

Touch to select the desired mode.  
 CW & Tone modes can transmit only one wavelength at a time

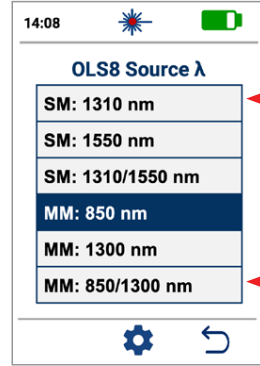

Touch to select the desired wavelengths.  
 CW & Tone modes transmit only one wavelength at a time.  
 If Wave ID mode is enabled, and dual wavelength option is selected, OLS8 transmits 2 wavelengths.

## OLS8 General Settings and Info



Touch a Setting to edit  
 Touch to display Info  
 Touch to display Home

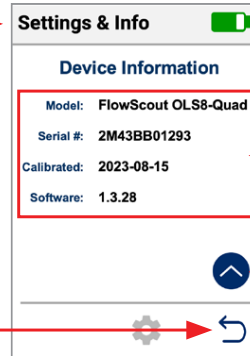

Device Info  
 Touch to return to Settings

**Contact the professionals at Fiber Optic Center for a quote or to get more details.**

## Measuring Optical Power with FlowScout® OPM8

It is important to keep all optical connections and surfaces clean to ensure accurate measurements and operation. Always clean all test jumpers before conducting tests.

1. Turn on OPM8 and display the Measurements screen by touching the Measurements soft button.
2. Select the appropriate fiber optic test jumper. The fiber type of this jumper must be the same as the fiber type connected to the output being measured.
3. Mount the appropriate adapter cap on the OPM8 test port. This adapter cap must match the connector on the end of the test jumper you will connect to the OPM8.
4. Connect one end of the test jumper to the OPM8 adapter cap and the other end to the optical output to be measured.
5. If operating in CW (not in Wave Id) mode, press the  $\lambda$  button to select wavelength that matches the nominal wavelength of the source being measured.
6. If needed, touch dB/dBm soft key to display power in dBm.
7. Press Save to save the displayed measurement in the OPM8 internal memory.
  - Results can be added to an existing project.
  - Or, saved a new project, where Project, End1/End2, Cable and Fiber number can be edited.

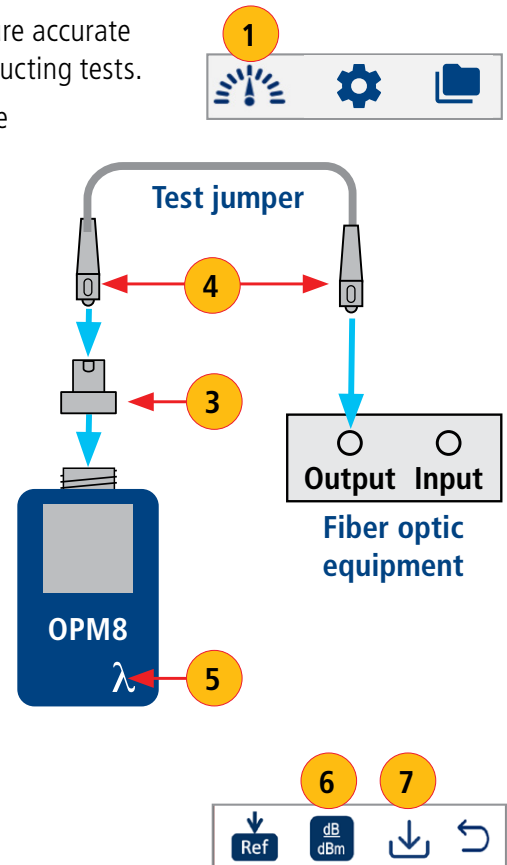

**Contact the professionals at Fiber Optic Center for a quote or to get more details.**

## Testing Fibers with FlowScout® OPM8 and OLS8

### Step I - Set the Reference (One Jumper Method)

1. Power on the OPM8 and OLS8.  
**On OLS8:** press the Light button to turn light on.
2. If not operating in the Wave ID mode, set both instruments to the desired wavelength.
3. Select transmit and receive jumpers. Fiber type of these jumpers must match link to be tested.
4. Connect the transmit jumper to the OLS8 output port.
5. Mount the appropriate adapter cap on the OPM8 optical test port. Adapter cap must match free connector on the transmit jumper.
6. Connect the transmit jumper to the OPM8. Display optical power in dBm.
7. If measured power is outside of the normal range (specified by manufacturer), clean all fiber connections or replace the transmit jumper. Repeat steps 4 - 7.
8. **Set reference level:** on OPM8, press and hold Ref/Set until HELD SET is displayed to store currently measured level as the new reference level. Once set, OPM8 switches to dB mode. OPM8 should display  $0 \text{ dB} \pm 0.05 \text{ dB}$ .

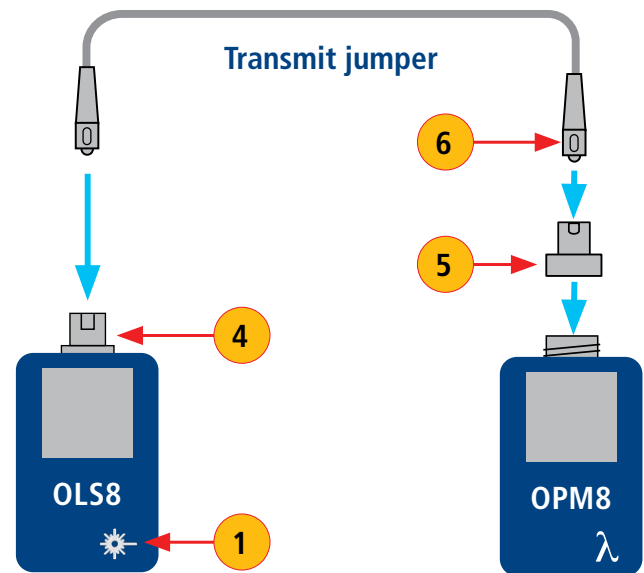

12

Contact the professionals at Fiber Optic Center for a quote or to get more details.

[focenter.com](http://focenter.com) • 508-992-6464 | (800) 473-4237 • [sales@focenter.com](mailto:sales@focenter.com)

23 Centre Street • New Bedford, MA 02740 USA

Product data subject to change  
without notice.

## Testing Fiber Links

### Step II - Verify Test Jumpers

9. Disconnect the transmit jumper from the OPM8. **Do not disturb the transmit jumper at the OLS8 end!**
10. Connect the receive jumper to the OPM8 test port equipped with the appropriate adapter cap.
11. Mate free ends of the transmit and receive jumpers using the appropriate adapter.
12. Verify that the insertion loss of this mated connector pair is under 0.75 dB - maximum allowed by TIA (AFL recommends 0.4 - 0.5 dB typical):
  - Observe the displayed value - insertion loss of the test jumpers in dB.
  - If value is not acceptable, disconnect transmit and receive jumpers at the adapter, clean free ends of both test jumpers and repeat steps 11 & 12.
  - If value is still not acceptable, replace test jumpers and repeat steps 1-12.
13. If loss value is acceptable, disconnect transmit and receive jumpers at the adapter.
14. Move the OPM8 and OLS8 to opposite ends of the fiber link to be tested.

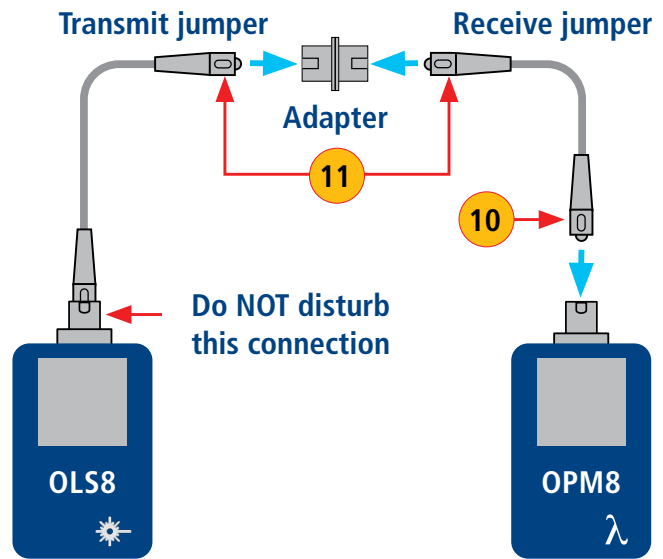

13

Contact the professionals at Fiber Optic Center for a quote or to get more details.

[focenter.com](http://focenter.com) • 508-992-6464 | (800) 473-4237 • [sales@focenter.com](mailto:sales@focenter.com)

23 Centre Street • New Bedford, MA 02740 USA

Product data subject to change without notice.

## Testing Fiber Links

### Step III - Measure Fiber Link Insertion Loss

15. Connect free ends of transmit and receive jumpers to the link under test.

**Clean jumper end that connects to patch panel prior to every test!**

16. OPM8 will measure and display the insertion loss of the link under test.

17. Press the Store key on the OPM85 to save the displayed measurement in the next available memory location.

18. Repeat steps 15-17 for all links to be tested at the current wavelength.

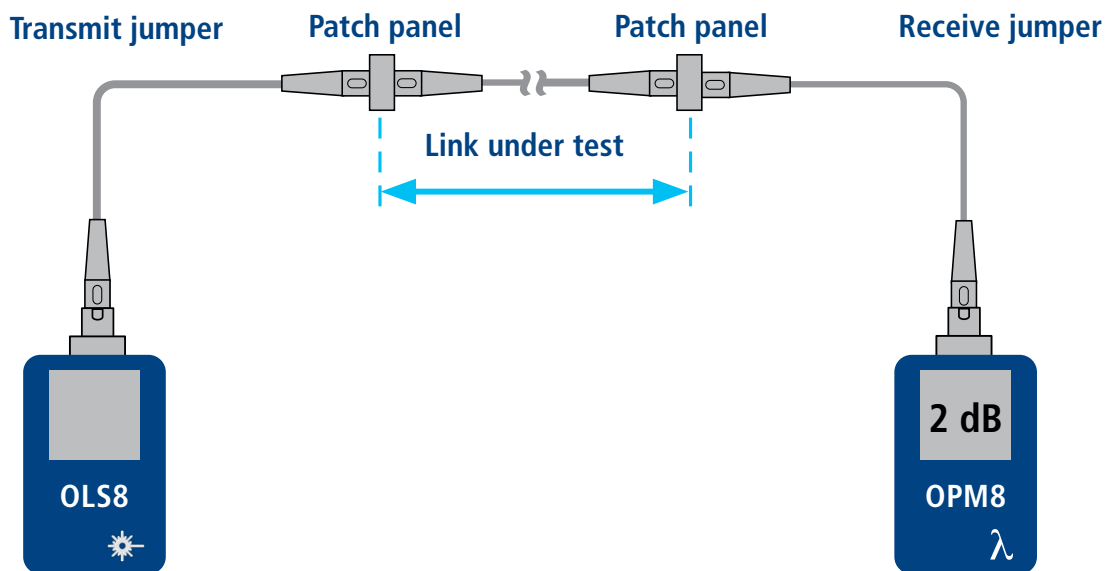

**Contact the professionals at Fiber Optic Center for a quote or to get more details.**

## OPM8 File Management and Reporting Software

File Management system allows simple organization of power or insertion loss measurements into multiple files. Using the AFL's FlexReports Test Results Manager software and USB connection, test records are transferred to a PC for analyzing, generating professional test reports, and printing.



- Simple USB transfer of saved files.
- View test results
- Save test results on your PC/network
- Organize standard loss test data into bi-directional loss test data
- Create professional reports for your customers
- Add link length to loss data and select standard rules to generate network certification reports for your customers.

**Contact the professionals at Fiber Optic Center for a quote or to get more details.**