

## Seiko Instruments SSC-PNE Series SC/APC Termination Procedures

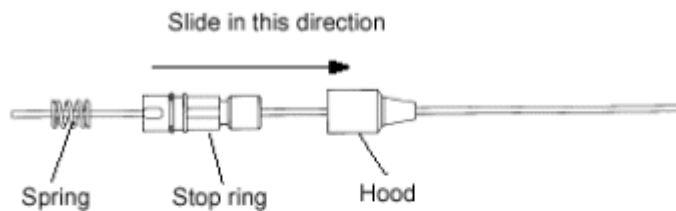

### 4.1 SLIDING THE CONNECTOR PARTS ONTO THE FIBER

Slide the connector parts onto the fiber as shown in the figure. Be sure the connector parts are installed in the right order and facing the correct direction.



### 4.2 STRIPPING THE FIBER END

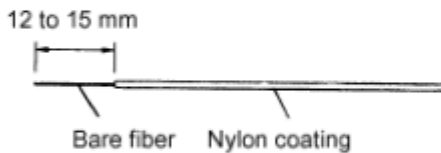

Step 1 Using the fiber stripper and a scale, remove 12 to 15 mm of the nylon coating from the end of the fiber as shown.

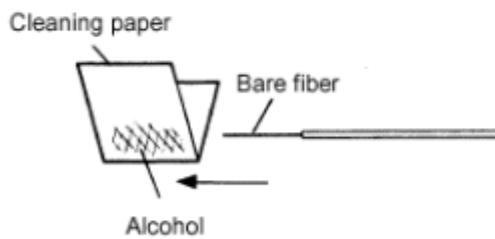

Step 2 Wipe off the residual coating with a piece of cleaning paper moistened with ethyl alcohol.

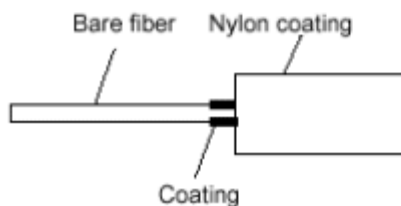

#### NOTE

If residual coating remains on the fiber, adhesion between the ferrule and the fiber may be degraded, leading to deterioration of the connector performance. Coating at the root of the bare fiber may be left because it is difficult to remove.

4.3 PREPARING ADHESIVE



Step 1 Mix the main and curing agents of the adhesive Epo-Tek 353ND according to the instructions printed on the package of Epo-Tek.

Step 2 Pour the mixture into the mixing cup and leave it for several minutes until the foam dissipates.

4.4 ADHERING FERRULE ONTO THE FIBER

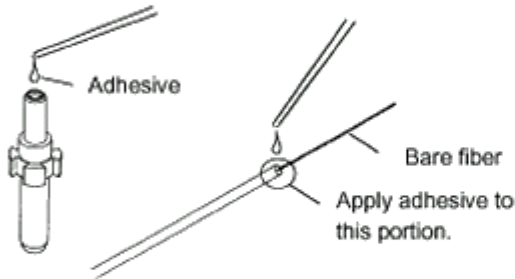

Step 1 Drip a few drops of adhesive into the hole of the tail of the ferrule. Also apply a drop of adhesive to the root of the bare fiber.

Step 2 Slide the ferrule onto the fiber slowly. Wipe off the excessive adhesive coming out of the tail of the ferrule.

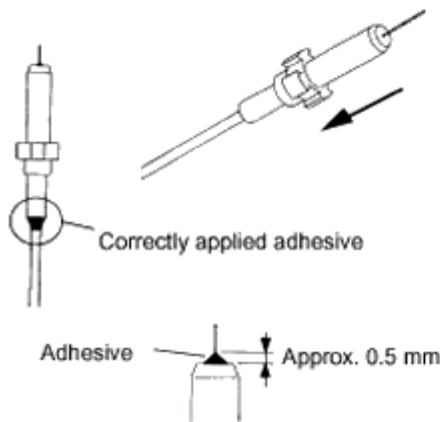

Step 3 Apply a small amount of adhesive on the root of the bare fiber protruding from the ferrule tip to cover about 0.5 mm.

NOTE

Take care not to apply adhesive to the chamfered portion or the side of the ferrule.

#### 4.5 HARDENING ADHESIVE



**Step 1** Harden the Epo-Tek 353ND by setting the ferrule (with the fiber inserted) into the curing machine OFK-1 or OFK-3. A maximum of 20 ferrules can be cured at a time in the OFK-1 and 24 in the OFK-3 (For more details, see the curing machine manual).

---

**CAUTION**

---

During and immediately after the curing, do not touch the ferrule or the heater of the curing machine because they are very hot. Use tweezers to take the ferrule out after curing.

---

**Step 2** After completion of the hardening, cut the fiber projecting from the face of the ferrule by making a notch by a slight touch of the fiber cutter and then lightly bending the fiber down to remove it.

---

**CAUTION**

---

Do not snap the fiber by applying excessive force with the fiber cutter. Otherwise, the fiber will be snapped inside the ferrule. Take care not to let the cut end of fiber fly off because it is dangerous.

---

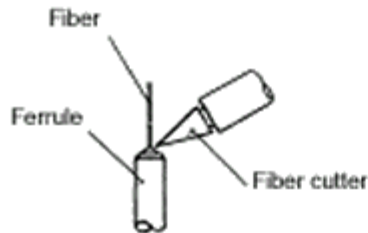

#### 4.6 POLISHING FERRULE (Skip this step if you are using a SNZ-3A ferrule type)

Polish the ferrule referring to *OFL-11/OFL-12/OFL-15 Instruction Manual* and Polishing Application Note.

4.7 CORE ECCENTRICITY ADJUSTMENT (Skip this step if you are using a SNZ-3A ferrule type)

This process is performed only when the single mode fiber is used.

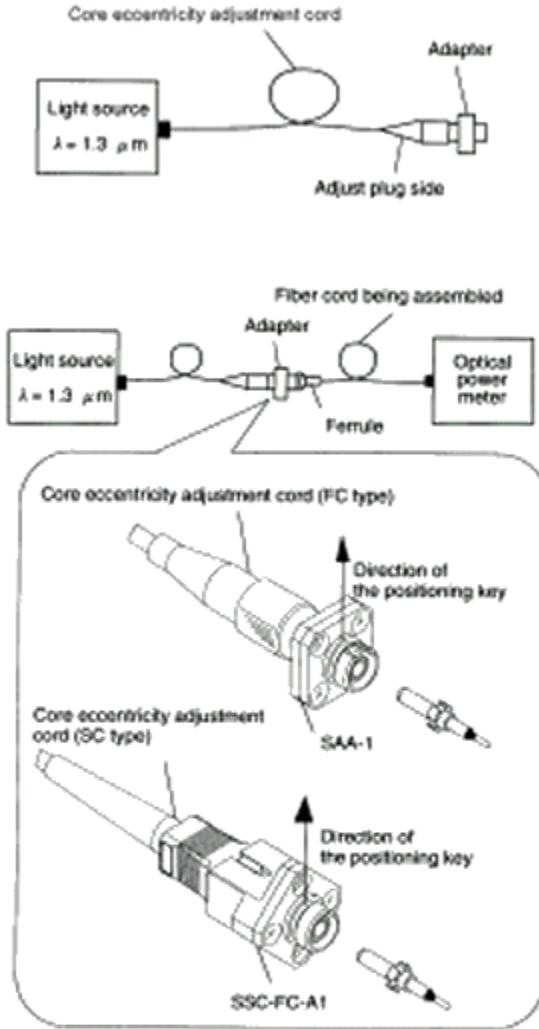

**Step 1** Prepare a light source, a core eccentricity adjustment cord, and an adapter, along with the fiber cord to be assembled with the connector. Wipe the ferrule end of the core eccentricity adjustment cord and the ferrule end of the fiber cord to be assembled with a piece of clearing paper moistened with ethyl alcohol. Also clean the inside of the split sleeve of the adapter.

**Step 2** Connect the light source, the core eccentricity adjustment cord, and the adapter as shown in the figure.

**Step 3** Connect the cord to be assembled and the optical power meter as shown in the figure. Insert the ferrule into the adapter in such a way that the notch of the ferrule aligns with the direction of the positioning key.

Be aware that the method of alignment with the positioning key varies with the type of connector.

**Step 4** Read the optical power meter.

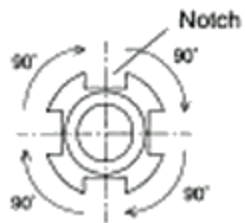

**Step 5** Pull the ferrule out of the adapter, rotate the ferrule by 90 degrees (or 180 degrees for a ferrule with two notches), insert it again into the adapter, and then read the optical power meter again.

**NOTE**

Do not rotate the ferrule while it is inserted in the adapter, otherwise the end surface of the fiber will be scratched and optical performance will be degraded.

Step 6 Repeat "Step 5" three times and take measurements for all four directions of the ferrule notches (For ferrules with four notches only).

Step 7 Mark the notch where the maximum optical power was measured with an oil-based marker.

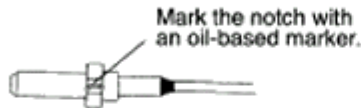

**4.8 FINAL ASSEMBLY**

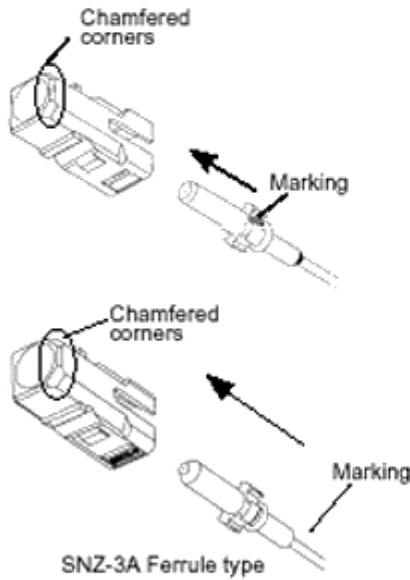

Step 1 Insert the ferrule into the plug frame with the marking on the ferrule aligned with the chamfered side of the plug frame. Take care that (1) the projections inside the plug frame are aligned with the notches in the ferrule, and that (2) the ferrule end projects from the plug frame by approx. 2 mm as shown in the figure.

**NOTE**

If you are using a SNZ-3A Ferrule type, insert the ferrule into the plug frame with the angle of the point of the ferrule as shown in the figure.

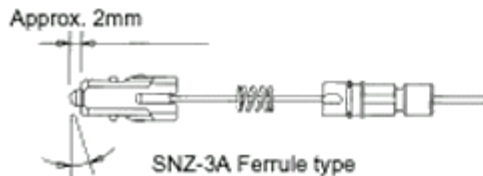

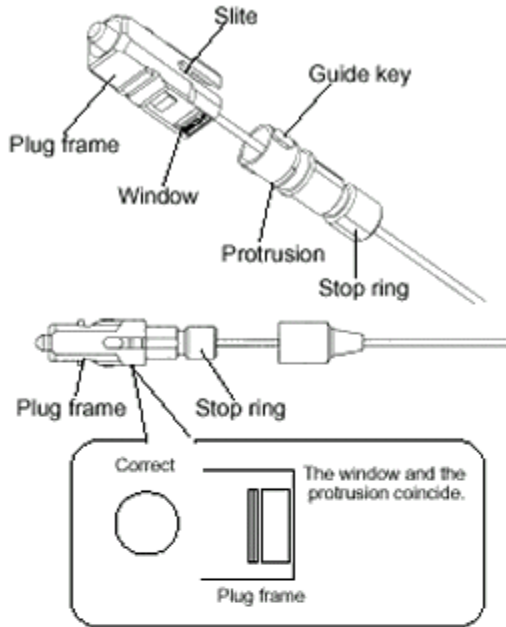

Step 2 Squeeze the stop ring into the plug frame while guide key of the stop ring toward the slite of the plug frame, until the stop ring clicks into place.

**NOTE**

Make sure the protrusion of the stop ring is engaged with the window of the plug frame.

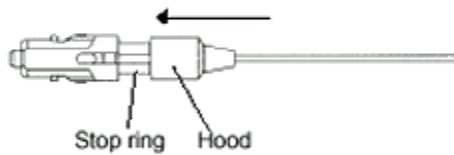

Step 3 Slide the hood onto the stop ring.

**4.9 GRIP ATTACHMENT**

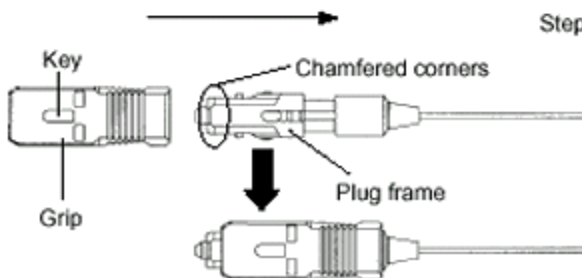

Step 1 Slide the grip onto the plug frame with the key on the grip and the chamfered side of the plug frame facing in the same direction until the grip clicks into place.

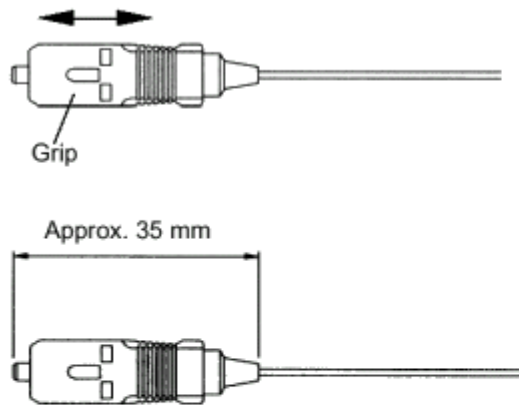

Step 2 Make sure that the grip slides smoothly.

Step 6 Make sure the length from the ferrule tip to the hood end is about 35 mm.

(Procedure for SSC-P1 SC Connector's assembly is finished in this step.)

#### 4.10 ANGLED-PC POLISHING FERRULE (SSC-PN1 SC Connector)

Polishing the ferrule referring to OFL-11/OFL-12/OFL-15 Instruction Manual, SC Plug jig Instruction Manual, and Polishing Application Note.